

## APPLICATIONS

Typical application for this fan is mechanical ventilation of hazardous zones and cargo tanks onboard ships. To be mounted into tank openings on deck.

## DESIGN

The MPV-A1EGSX is designed primarily for mechanical ventilation of cargo tanks and other places where explosive fumes occur. The fan is spark proof with a water driven or compressed air driven motor.

## EXECUTION

Fan casing consists of sea water resistant aluminium in a heavy-duty design. The propeller is made of salt- and ammonia resistant aluminium or reinforced polypropylene. Aerodynamically shaped and balanced. The wire mesh guard is made of stainless steel.

The MPV-A1EGSX can be delivered in the range from size no 300 to size no 500. PCD diameter can be adjusted to suit customers' requirements.

## MOTOR

Seawater or compressed air driven.

## CLASSIFICATION SOCIETIES

The fan satisfies the demands of the various classification societies.

## ACCESSORIES (water driven fan)

- Trolley
- Waterhoses inlet/outlet
- Collapsible air duct

## ACCESSORIES (air driven fan)

- Trolley
- Air hose, drive air
- Air filter / oiler
- Collapsible air duct



PORTABLE GAS FREEING FAN

MPV - A1EGSX

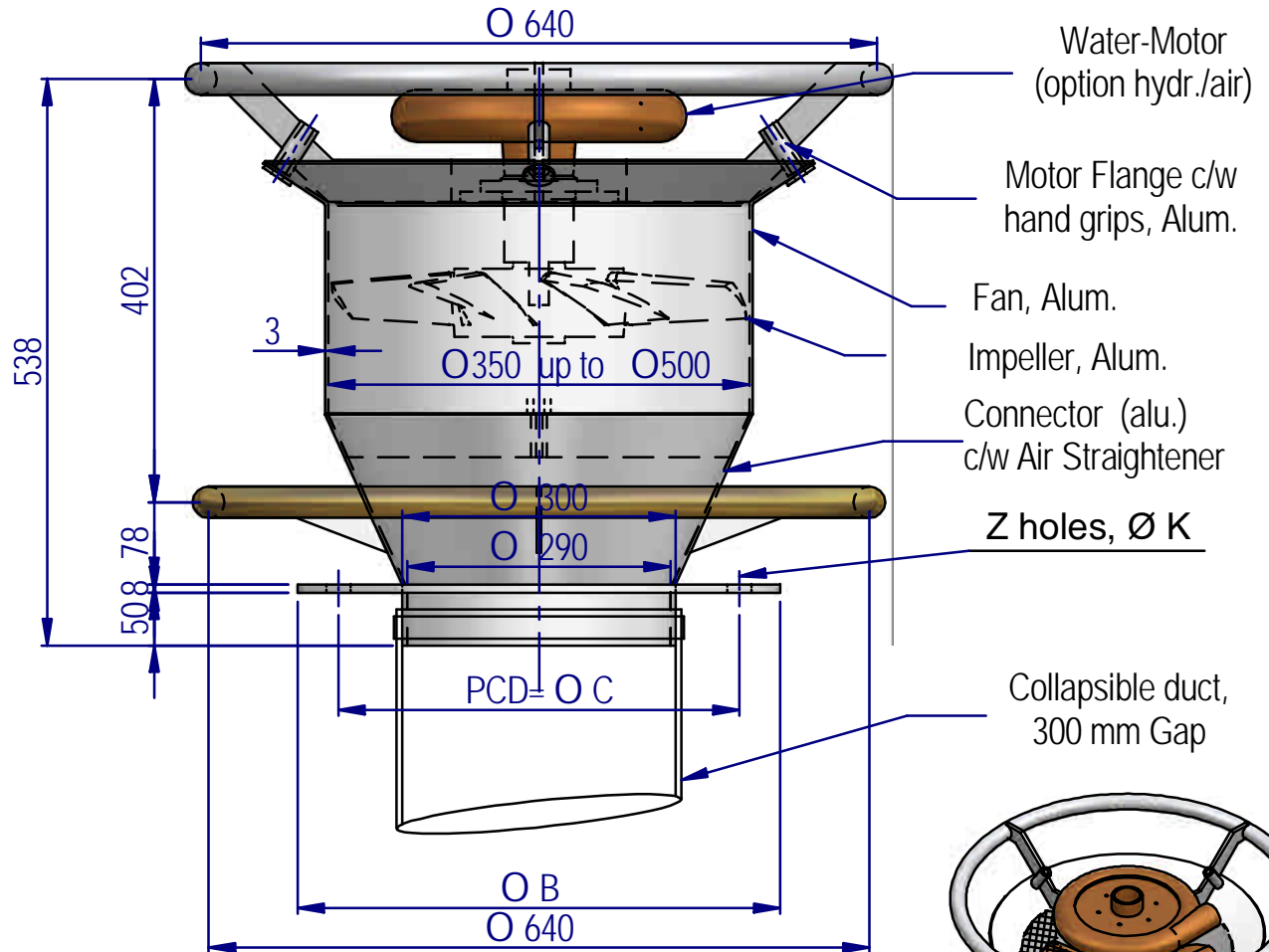

Dimensions for PCD, B, Size and No. of holes can be adjusted to meet customer's requirements.

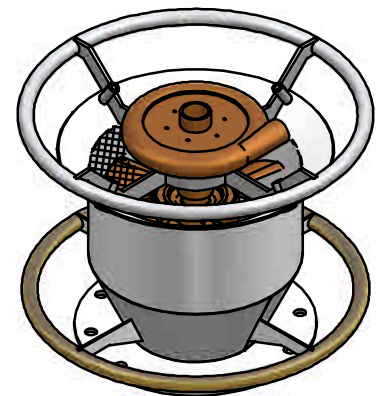

Wire Guard, AISI 316L

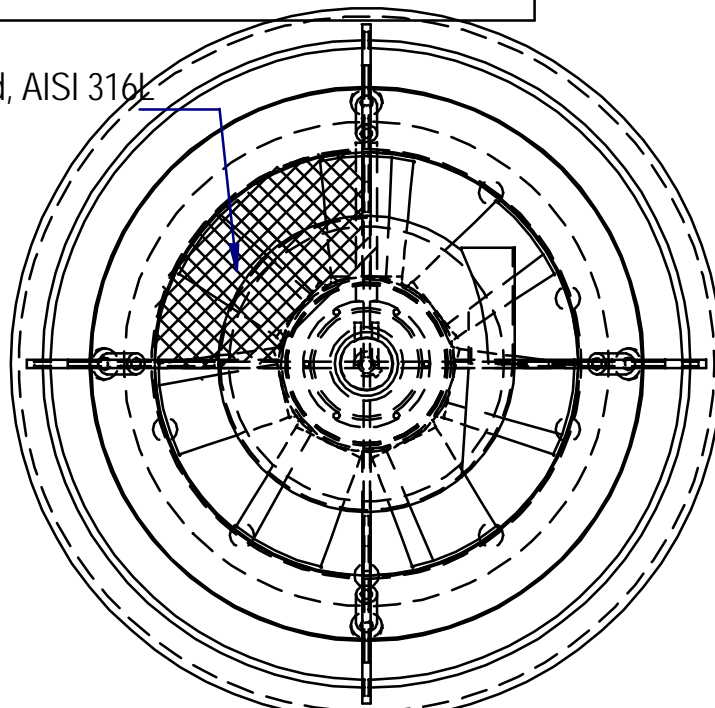

Fan size	Weight fan with motor [kg]
350	25
400	26
450	27
500	28
Trolley (option)	11,5
Air motor (option)	+1

4-2158

N Y B O R G A S

R.Berge  
12/09-03

N-6230 SYKKYLVEN, NORWAY  
TEL +47 70 25 40 80 - FAX +47 70 25 29 08  
office@nyborgfan.com - www.nyborgfan.com

MPV - A1EGSX



PORTABLE GAS-FREEING FAN  
ARRANGEMENT HOSES, PRINCIPLE SKETCH

MPV 300/450  
A1EGSX

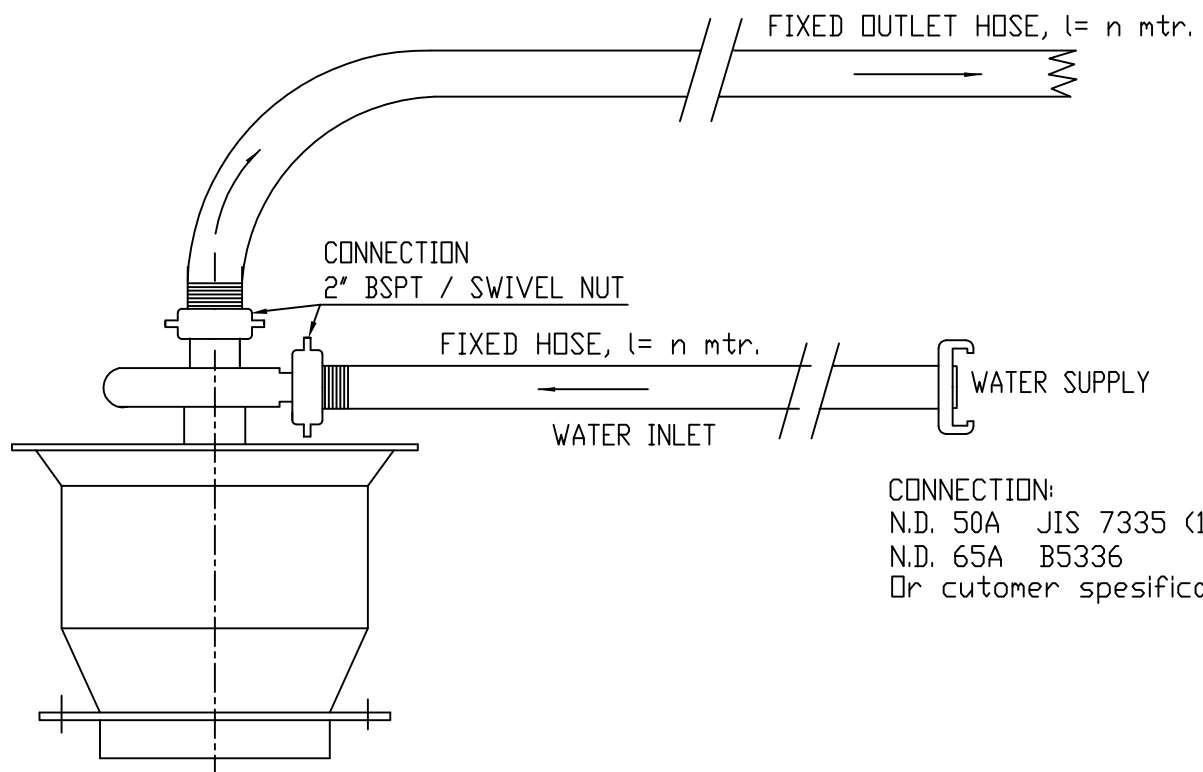

Date : 05.03.98

Tegn : 4-1324

Name : M.Berge

N Y B O R G A S

N-6230 SYKKYLVEN - NORWAY

Tel: +47 70 25 40 80 - Fax +47 70 25 29 08

E-MAIL: office@nyborgfan.com - WEB: www.nyborgfan.com

MPV 300/450  
A1EGSX



# WATER INLET HOSE

MPV 300/450  
A1EGSX

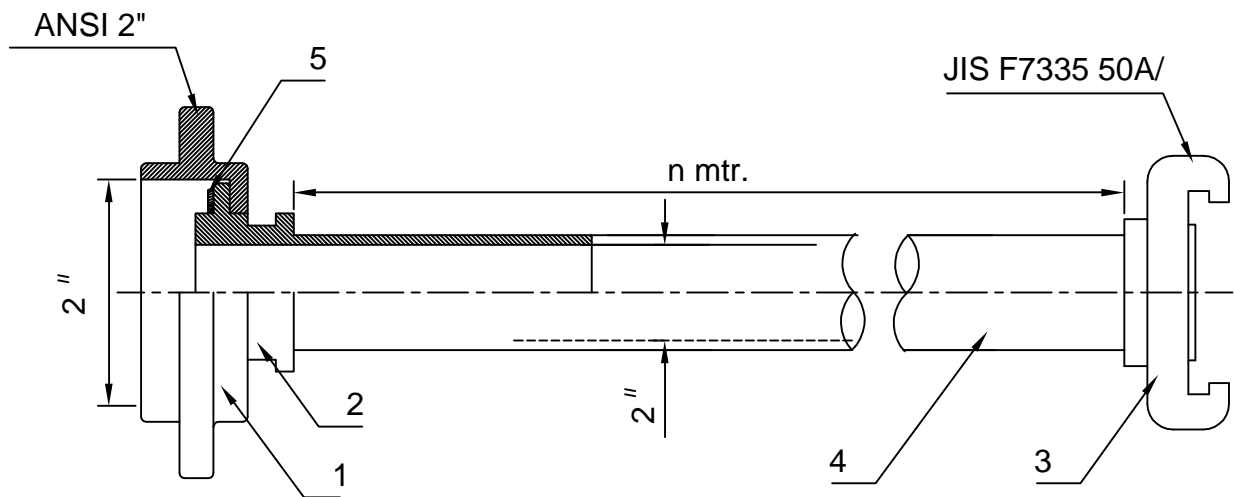

5	1	Packing	Neopr
4	1	Hose, Armtex	
3	1	Nakajima joint	Brass
2	2	Hose nipple	Brass
1	1	Swivel nut	Brass
Item	Qty	Part/Description	Matr.

Date : 05.03.98

Tegn : 4-1327

Name : M.Berge

N Y B O R G A S

N-6230 SYKKYLVEN - NORWAY

Tel: +47 70 25 40 80 - Fax +47 70 25 29 08

E-MAIL: office@nyborgfan.com - WEB: www.nyborgfan.com

MPV 300/450  
A1EGSX



# WATER OUTLET HOSE

MPV 300/450  
A1EGSX

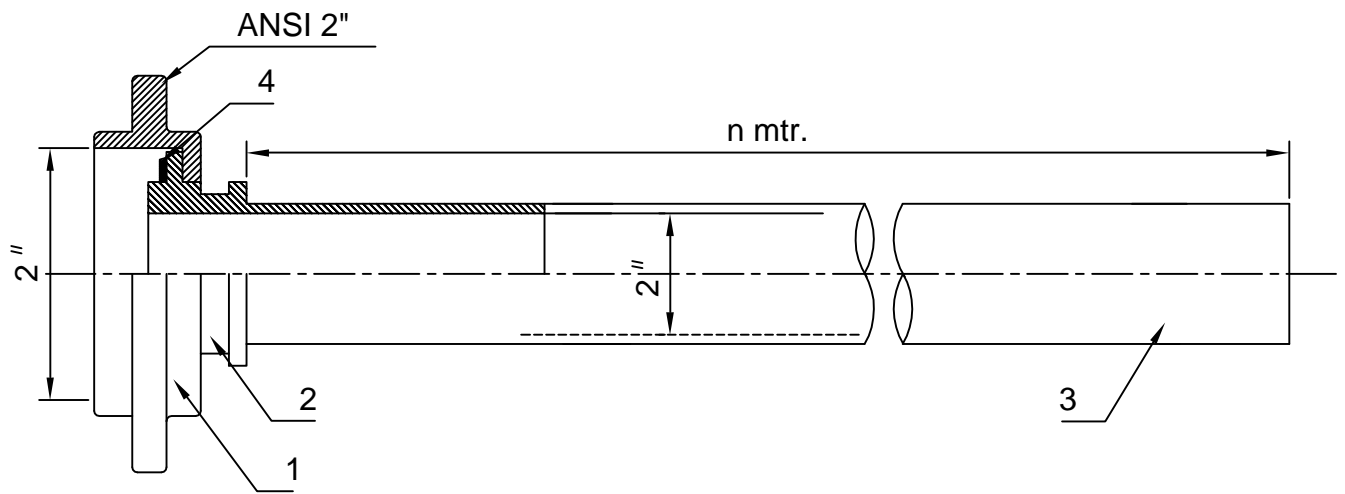

4	1	Packing	Neopr
3	1	Hose, Heliflat	
2	2	Hose nipple	Brass
1	1	Swivel nut	Brass
Item	Qty	Part	Matr.

Date : 05.03.98

Tegn : 4-1326

Name : M.Berge

N Y B O R G A S

N-6230 SYKKYLVEN - NORWAY

Tel: +47 70 25 40 80 - Fax +47 70 25 29 08

E-MAIL: office@nyborgfan.com - WEB: www.nyborgfan.com

MPV 300/450  
A1EGSX



# AIR DUCT, COLLAPSIBLE

MPV 300/450  
A1EGSX

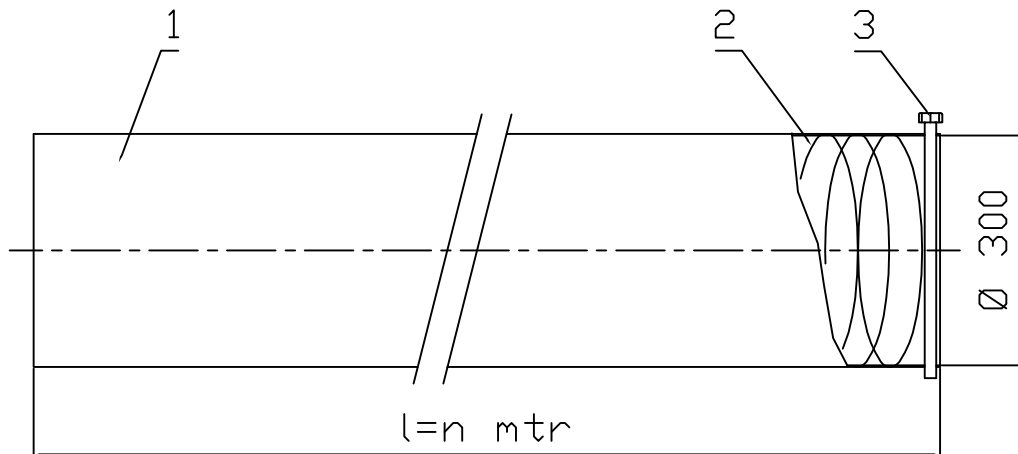

3	1	Hose clamp	St.37
2	1	Wire reinf.	St.37
1	1	Hose	Nylon
Item	Qty	Part/Descript.	Material

Date : 05.03.98

Tegn : 4-1325

Name : M.Berge

**N Y B O R G A S**

N-6230 SYKKYLVEN - NORWAY

Tel: +47 70 25 40 80 - Fax +47 70 25 29 08

E-MAIL: office@nyborgfan.com - WEB: www.nyborgfan.com

MPV 300/450  
A1EGSX



# NYBORG AXIAL FLOW FAN PERFORMANCE DATA

**MPV 350 A**  
Imp: A6T / 22

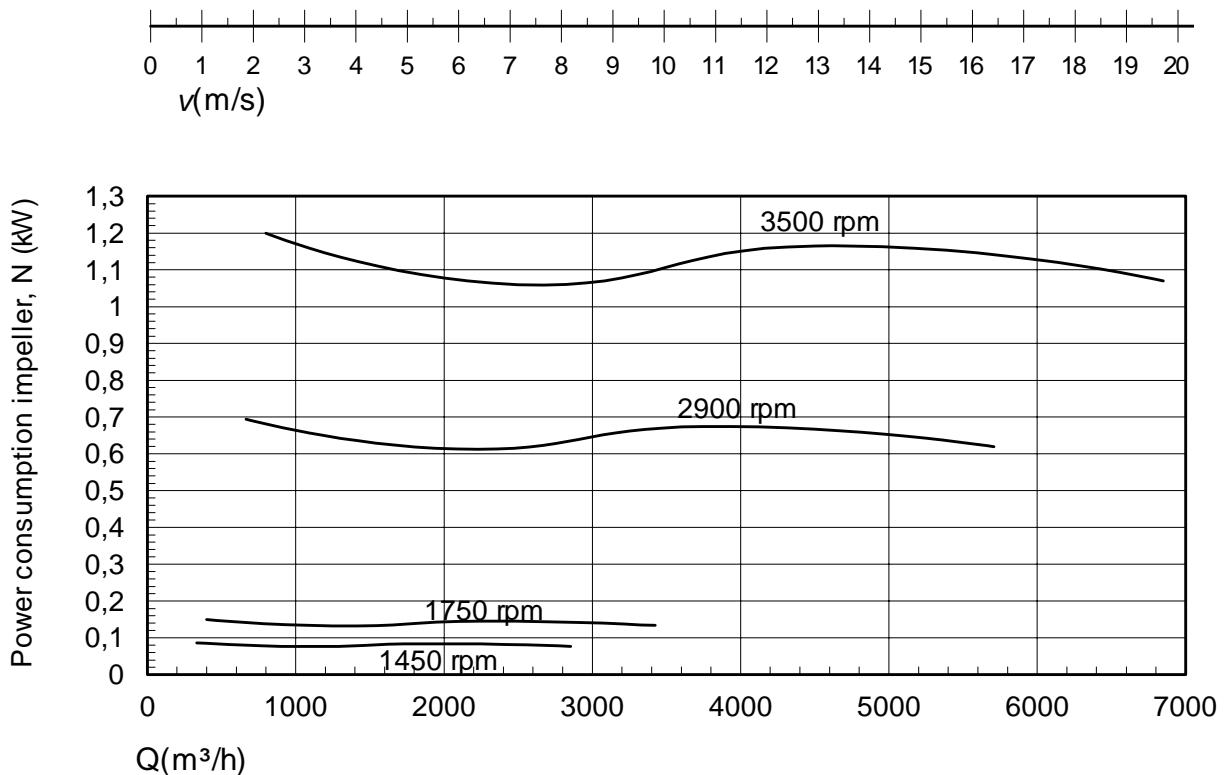
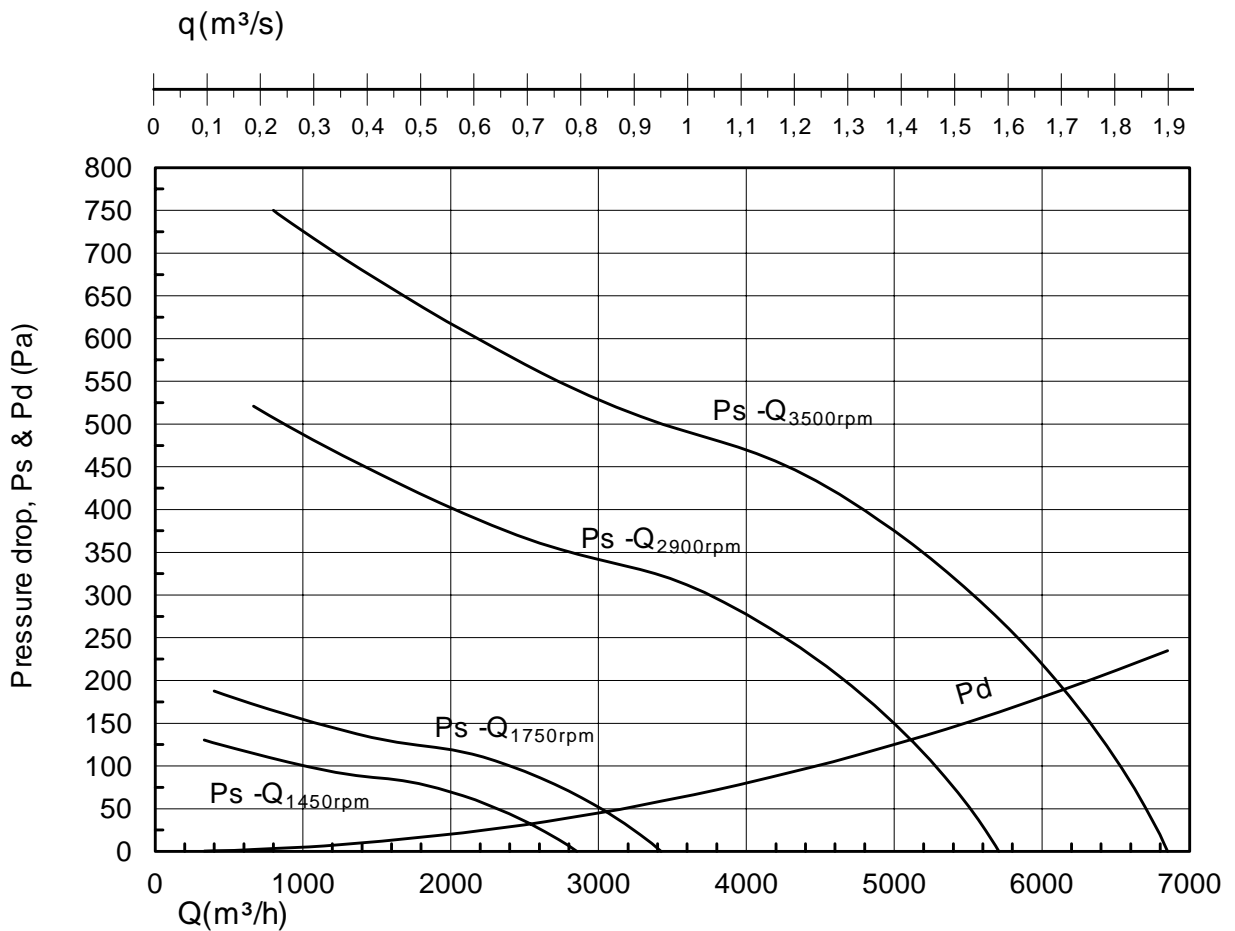

N Y B O R G A S

nyborg12.prs/29

N-6230 SYKKYLVEN, NORWAY  
TEL +47 70 25 40 80 - FAX +47 70 25 29 08  
E-mail : office@nyborgfan.com - www.nyborgfan.com

**MPV 350 A**



# NYBORG AXIAL FLOW FAN PERFORMANCE DATA

**MPV 400 A**  
Imp: A7T / 22

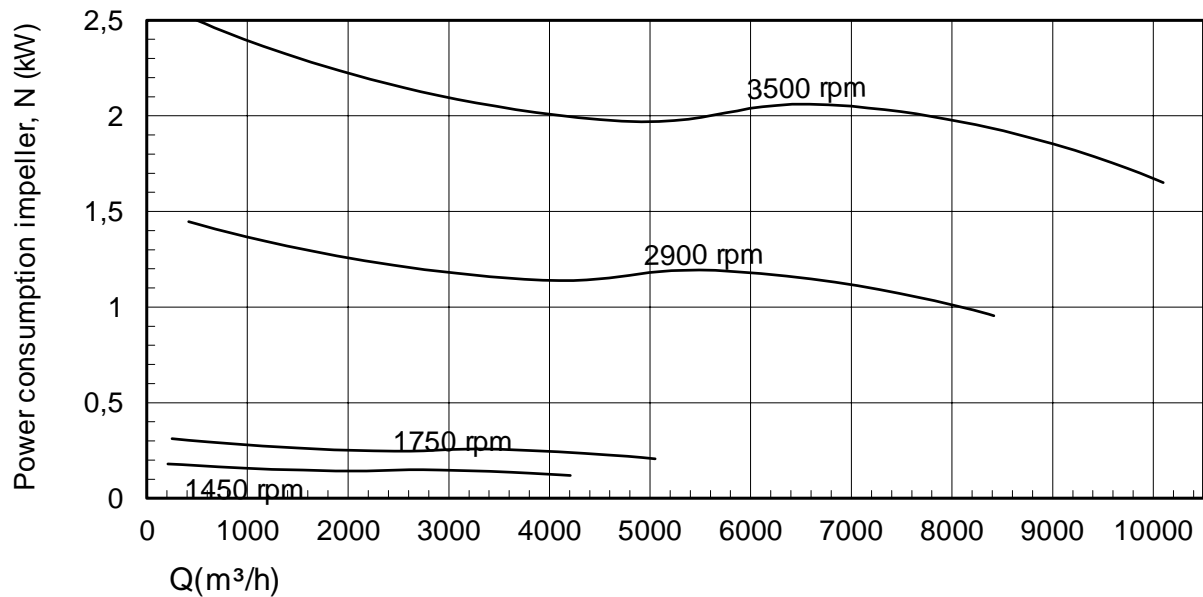
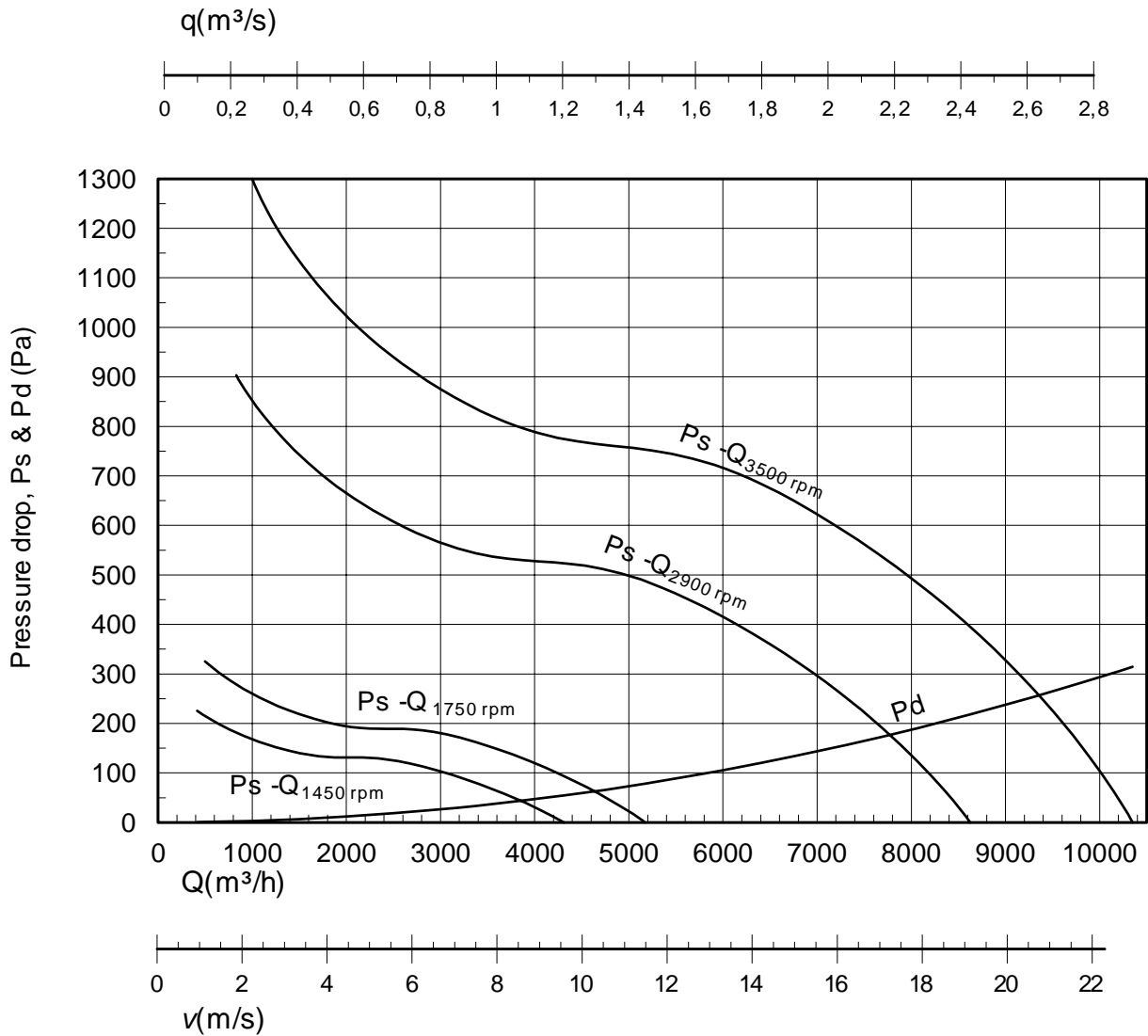

N Y B O R G A S

nyborg12.prs/38

N-6230 SYKKYLVEN, NORWAY  
TEL +47 70 25 40 80 - FAX +47 70 25 29 08  
office@nyborgfan.com - www.nyborgfan.com

**MPV 400 A**



# NYBORG AXIAL FLOW FAN PERFORMANCE DATA

**MPV 450 A**  
Imp: A7T / 22

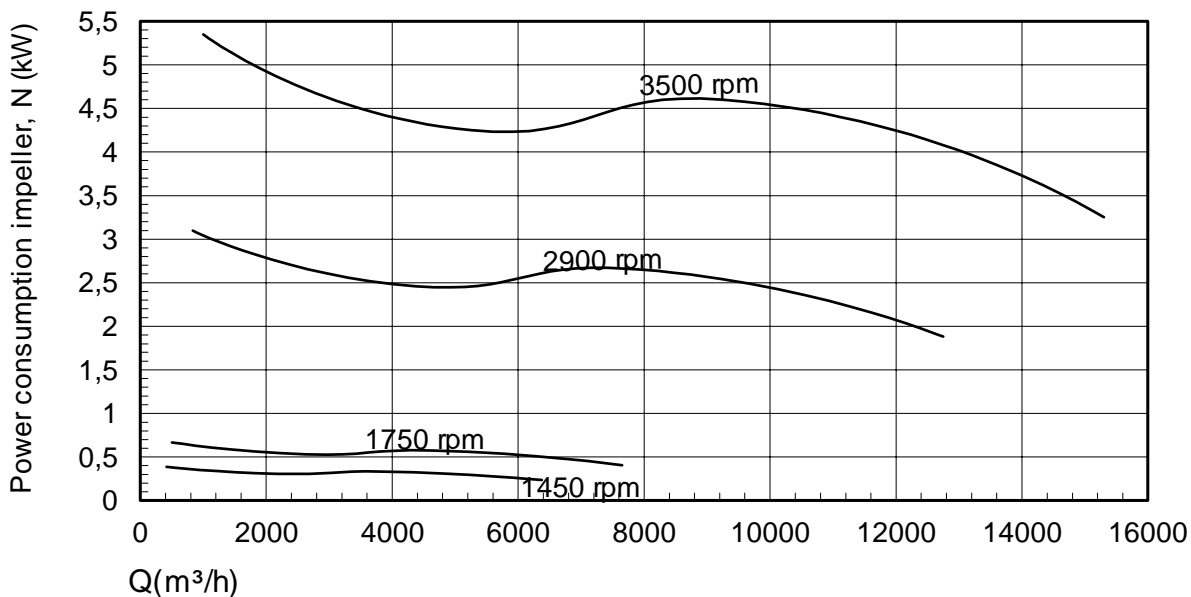
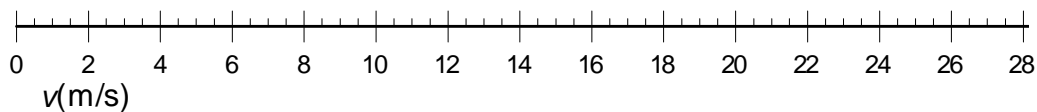
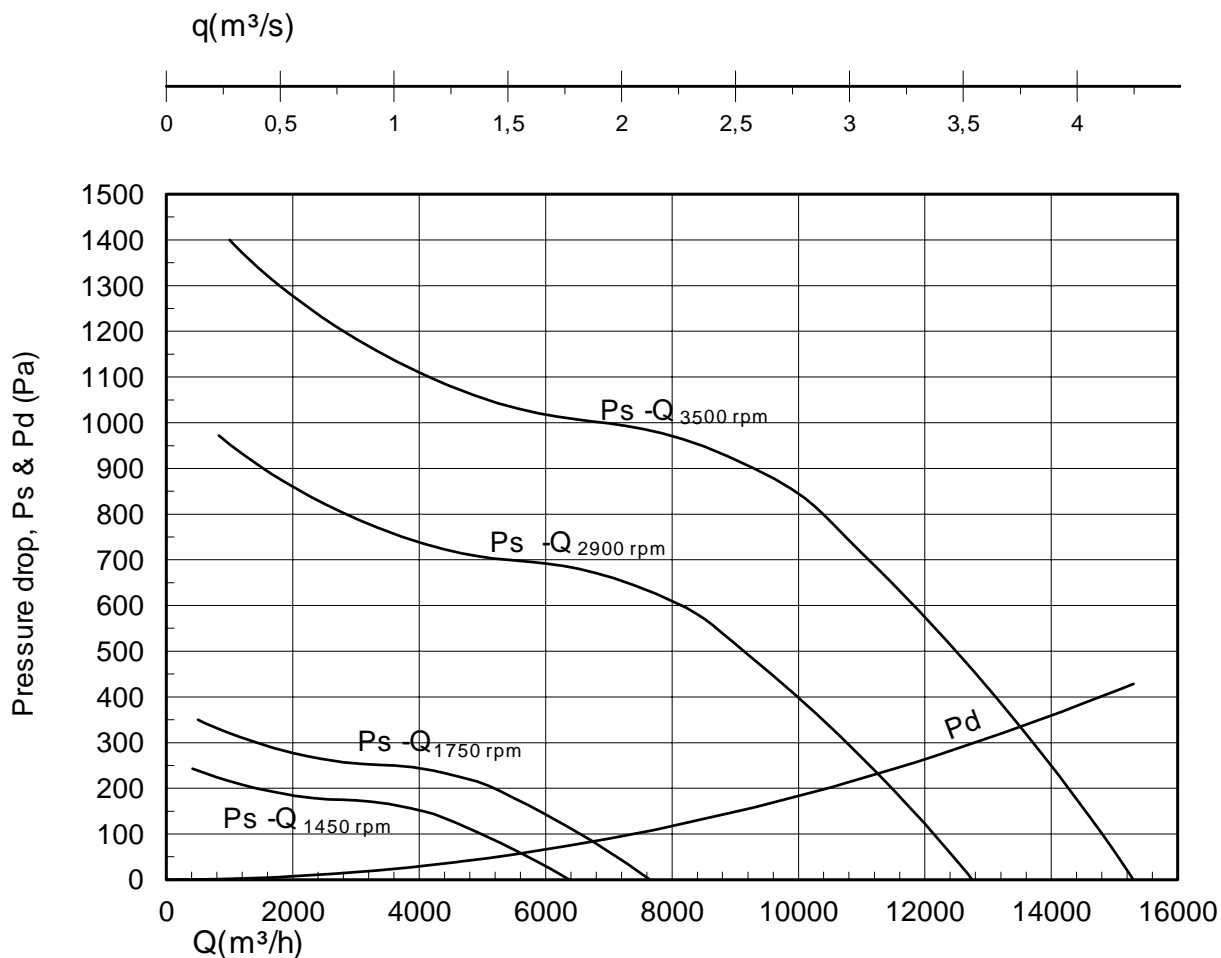

N Y B O R G A S

nyborg12.prs/33

N-6230 SYKKYLVEN, NORWAY  
TEL +47 70 25 40 80 - FAX +47 70 25 29 08  
office@nyborgfan.com - www.nyborgfan.com

**MPV 450 A**



# NYBORG AXIAL FLOW FAN PERFORMANCE DATA

**MPV 500 A**  
Imp: A7T / 22

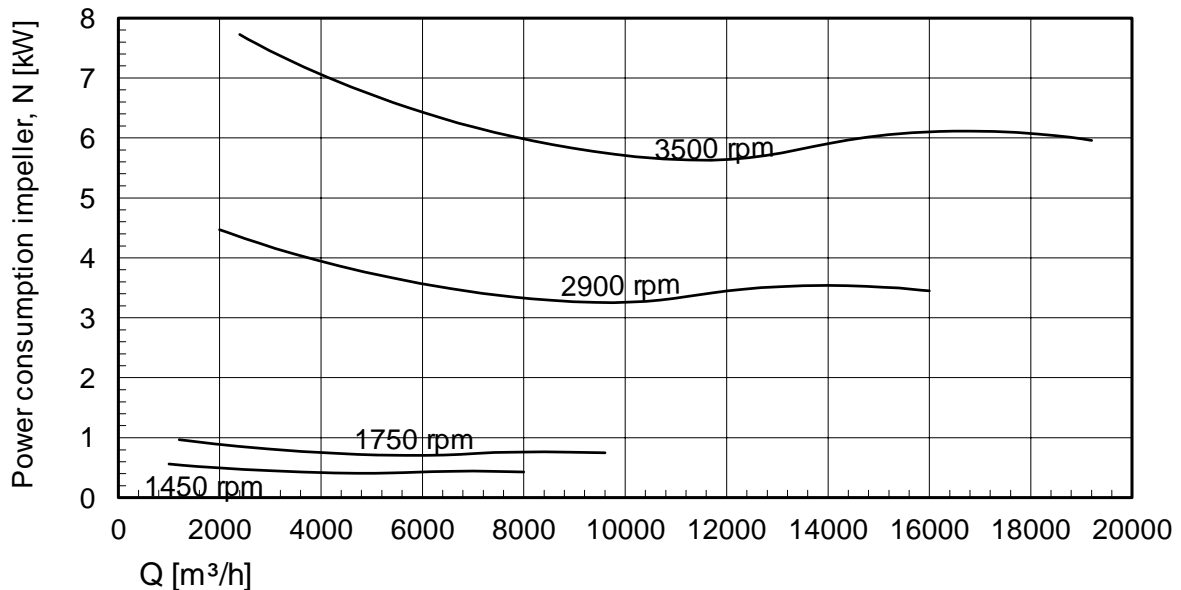
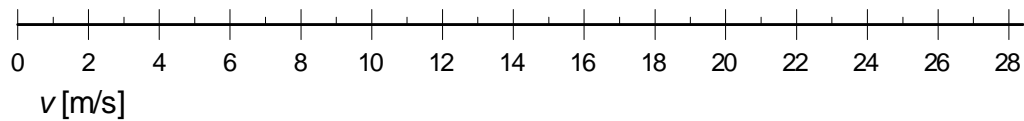
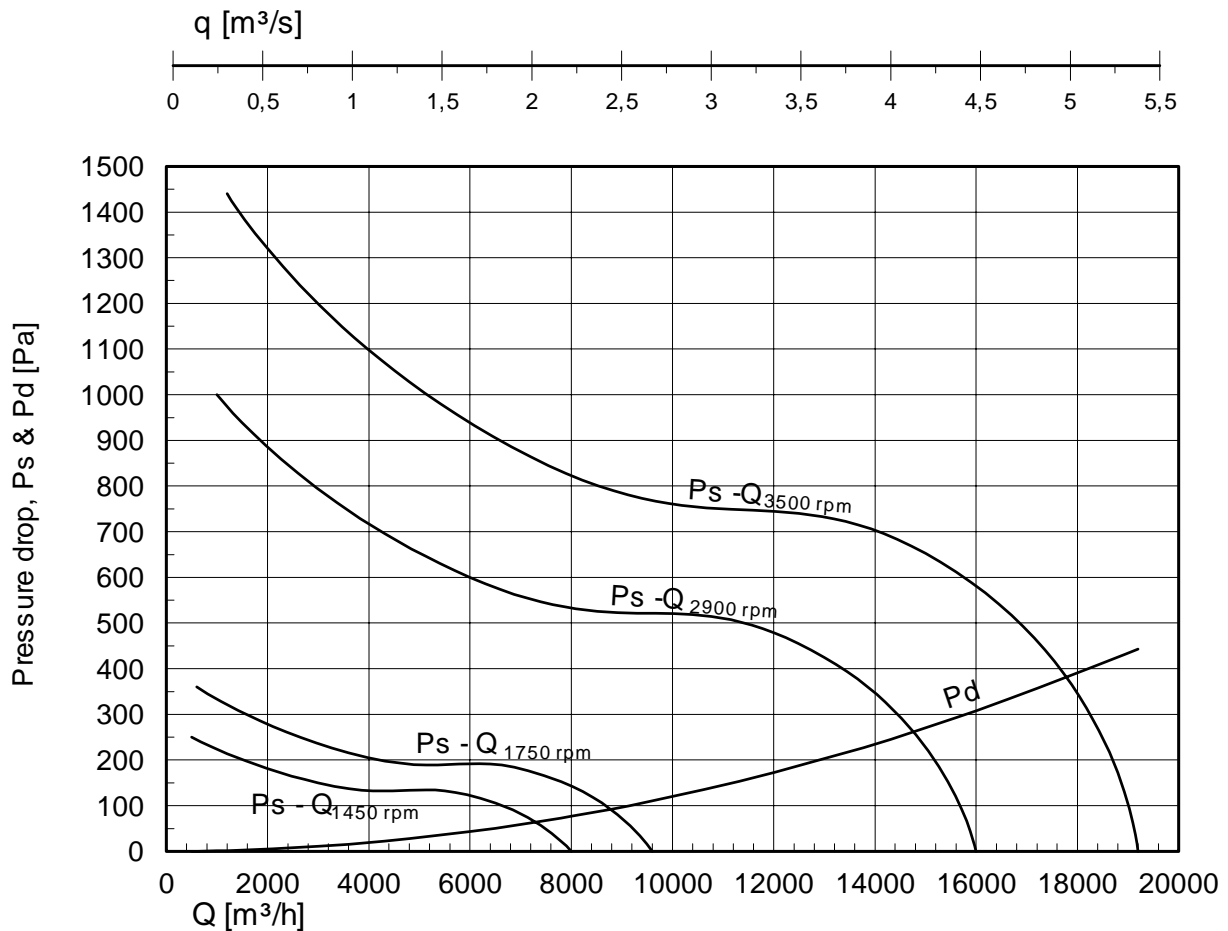

N Y B O R G A S

nyborg12.prs/13

N-6230 SYKKYLVEN, NORWAY  
TEL +47 70 25 40 80 - FAX +47 70 25 29 08  
office@nyborgfan.com - www.nyborgfan.com

**MPV 500 A**



# NYBORG PORTABLE AXIAL FLOW FAN WATER CONSUMPTION CHART

## MPV - A1EGSX

WATER MOTOR : GILKES 3,25F WM 0,10 VENT

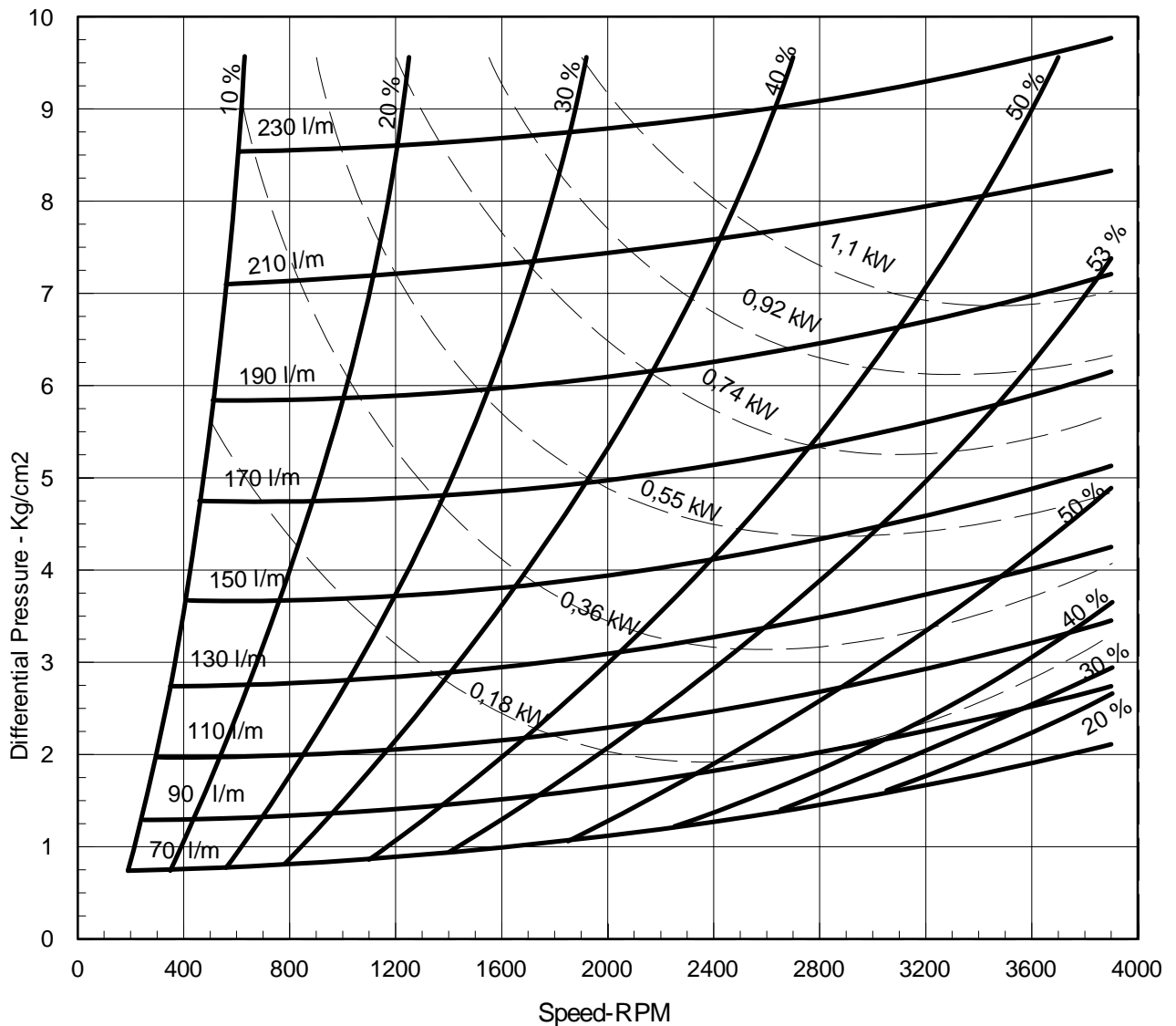

N Y B O R G A S

N-6230 SYKKYLVEN, NORWAY  
TEL +47 70 25 40 80 - FAX +47 70 25 29 08  
office@nyborgfan.com - www.nyborgfan.com

## MPV - A1EGSX



# NYBORG PORTABLE AXIAL FLOW FAN WATER CONSUMPTION CHART

## MPV - A1EGSX

WATER MOTOR : GILKES 3,25F WM 0,15 VENT

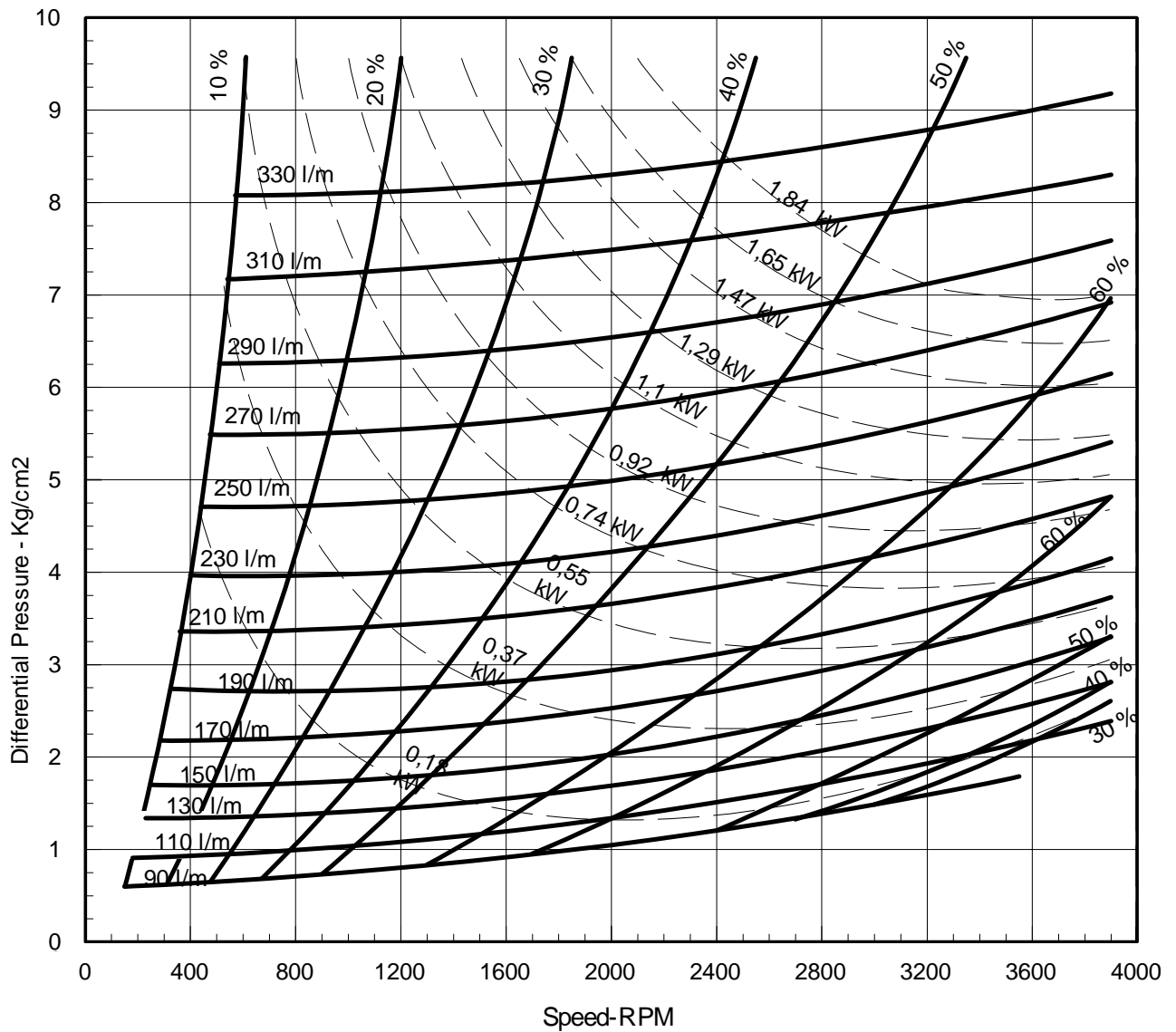

N Y B O R G A S

N-6230 SYKKYLVEN, NORWAY  
TEL +47 70 25 40 80 - FAX +47 70 25 29 08  
office@nyborgfan.com - www.nyborgfan.com

## MPV - A1EGSX



# NYBORG PORTABLE AXIAL FLOW FAN WATER CONSUMPTION CHART

## MPV - A1EGSX

WATER MOTOR : GILKES 3,25F WM 0,20 VENT

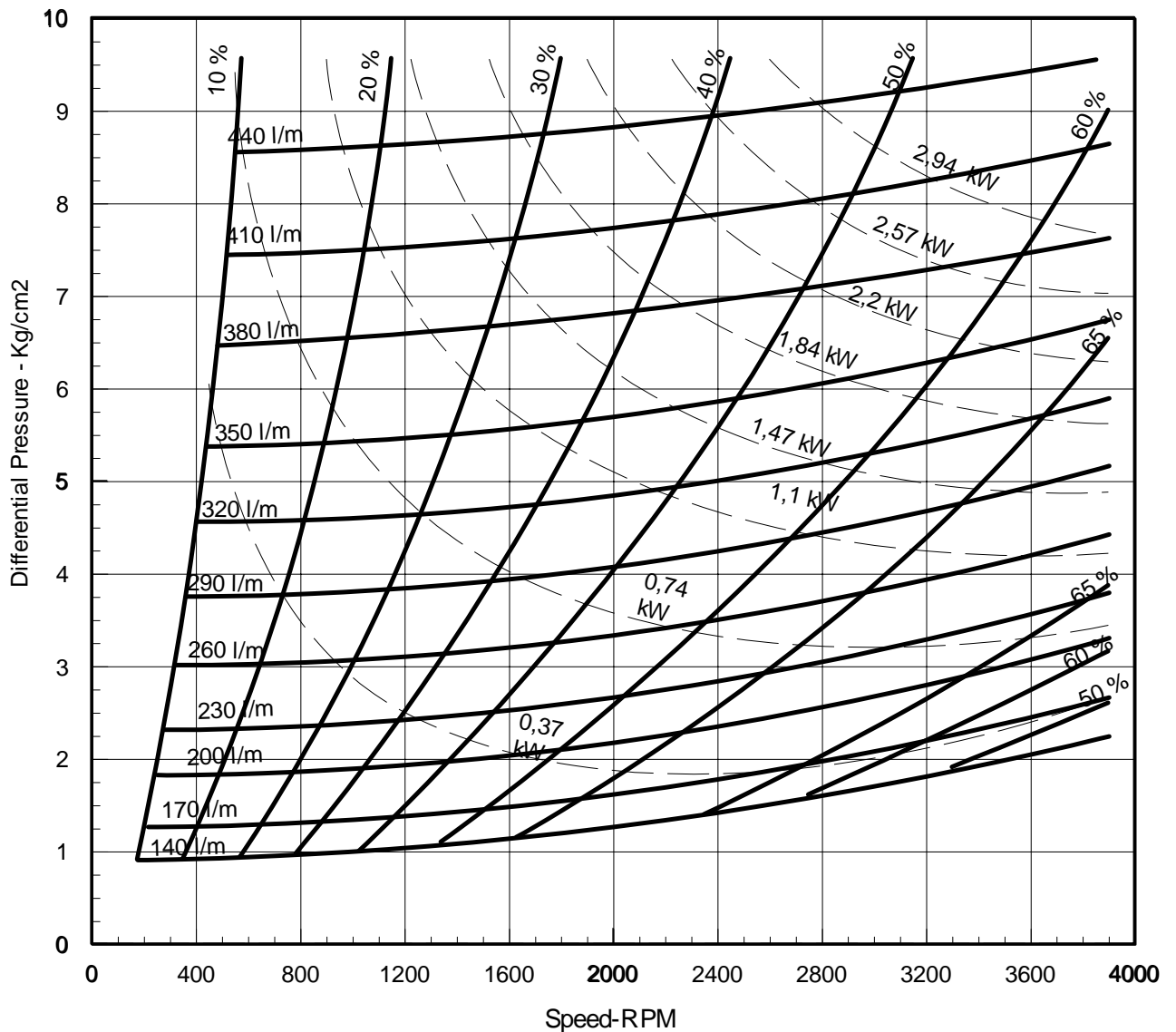

N Y B O R G A S

N-6230 SYKKYLVEN, NORWAY  
TEL +47 70 25 40 80 - FAX +47 70 25 29 08  
office@nyborgfan.com - www.nyborgfan.com

## MPV - A1EGSX



# NYBORG PORTABLE AXIAL FLOW FAN WATER CONSUMPTION CHART

## MPV - A1EGSX

WATER MOTOR : GILKES 3,25F WM 0,25 VENT

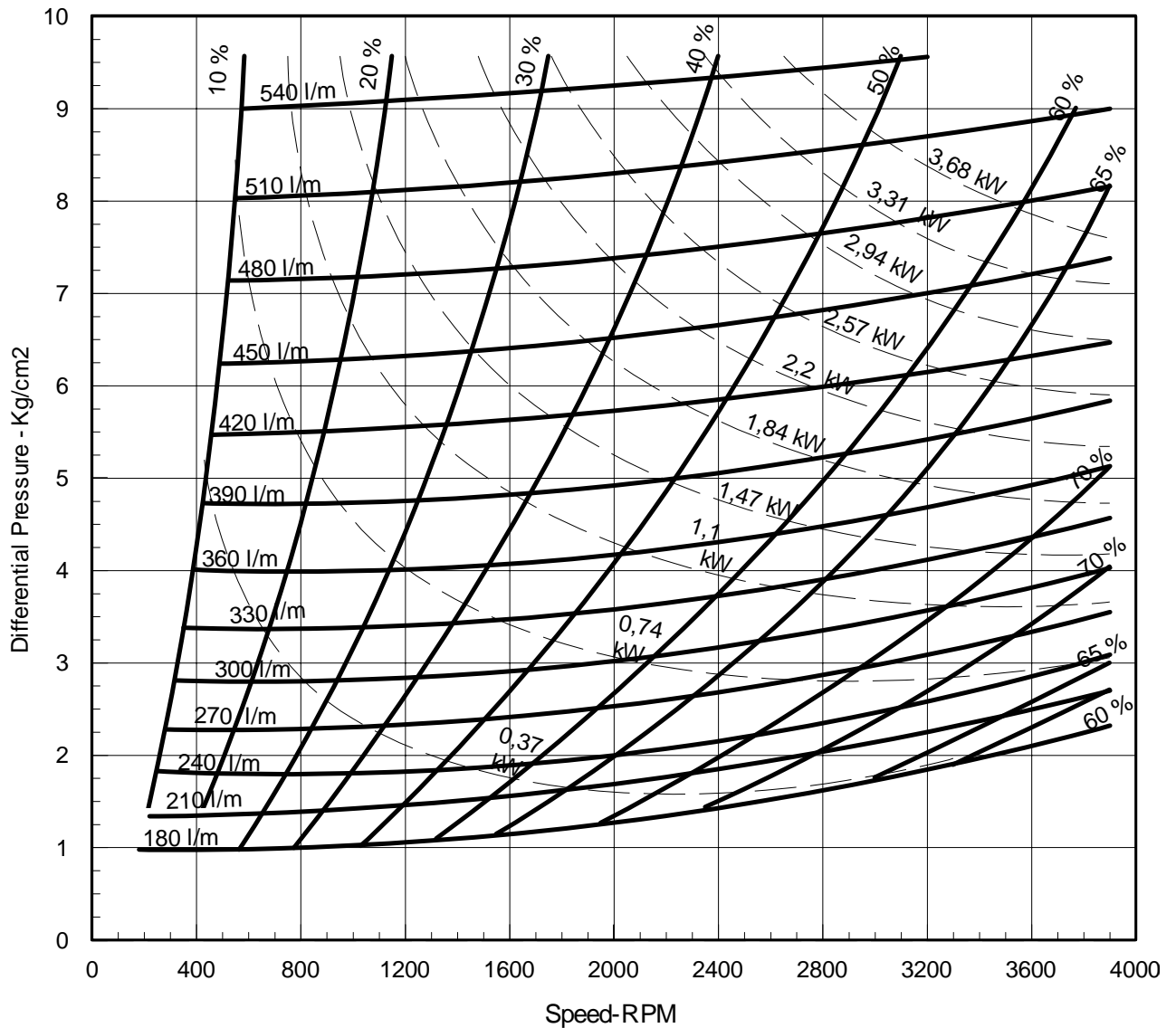

N Y B O R G A S

N-6230 SYKKYLVEN, NORWAY  
TEL +47 70 25 40 80 - FAX +47 70 25 29 08  
office@nyborgfan.com - www.nyborgfan.com

## MPV - A1EGSX



# NYBORG PORTABLE AXIAL FLOW FAN WATER CONSUMPTION CHART

## MPV - A1EGSX

WATER MOTOR : GILKES 3,25F WM 0,30 VENT

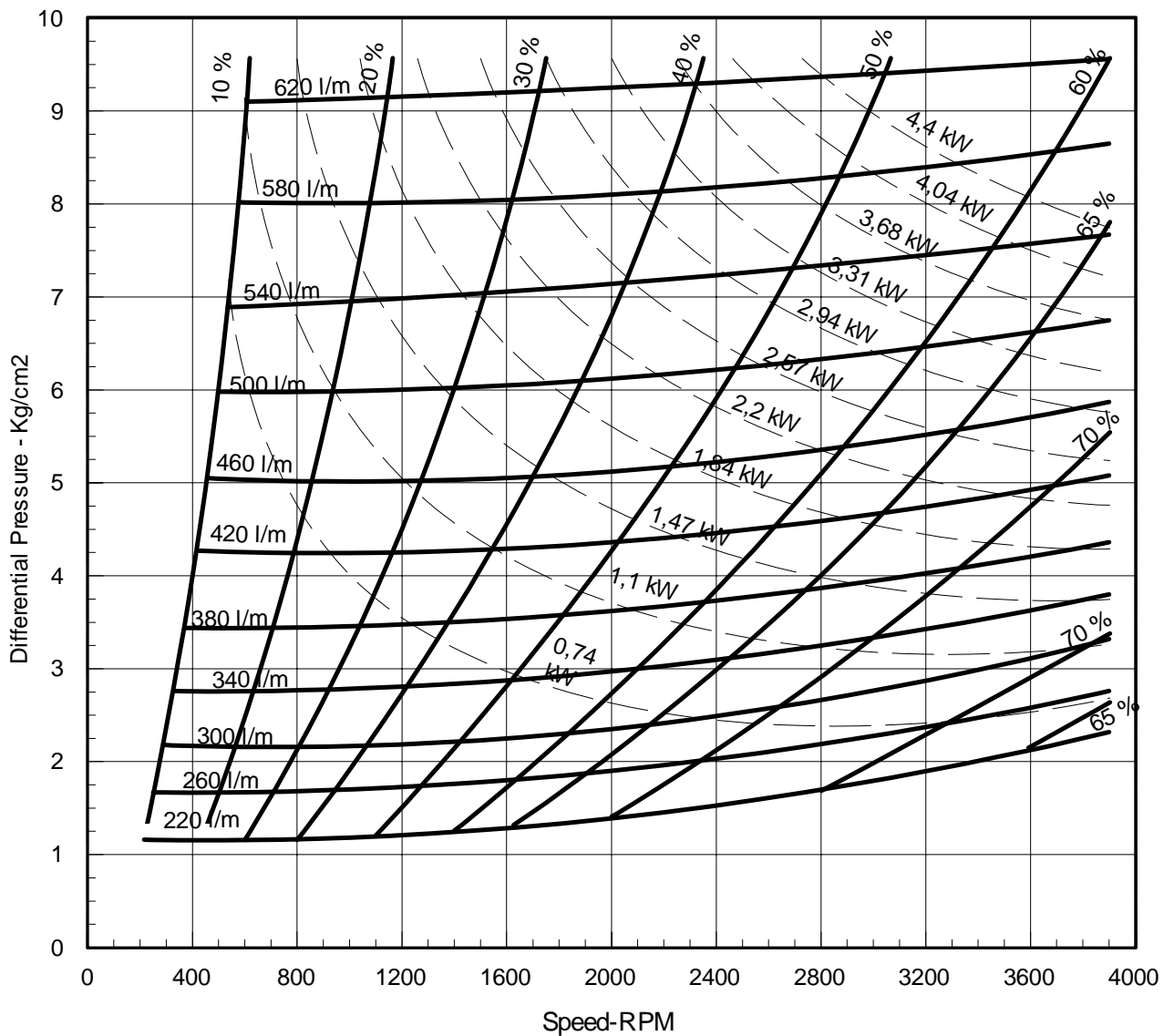

N Y B O R G A S

N-6230 SYKKYLVEN, NORWAY  
TEL +47 70 25 40 80 - FAX +47 70 25 29 08  
office@nyborgfan.com - www.nyborgfan.com

## MPV - A1EGSX



# NYBORG PORTABLE AXIAL FLOW FAN WATER CONSUMPTION CHART

## MPV - A1EGSX

WATER MOTOR : GILKES 4,25F WM 0,10 VENT

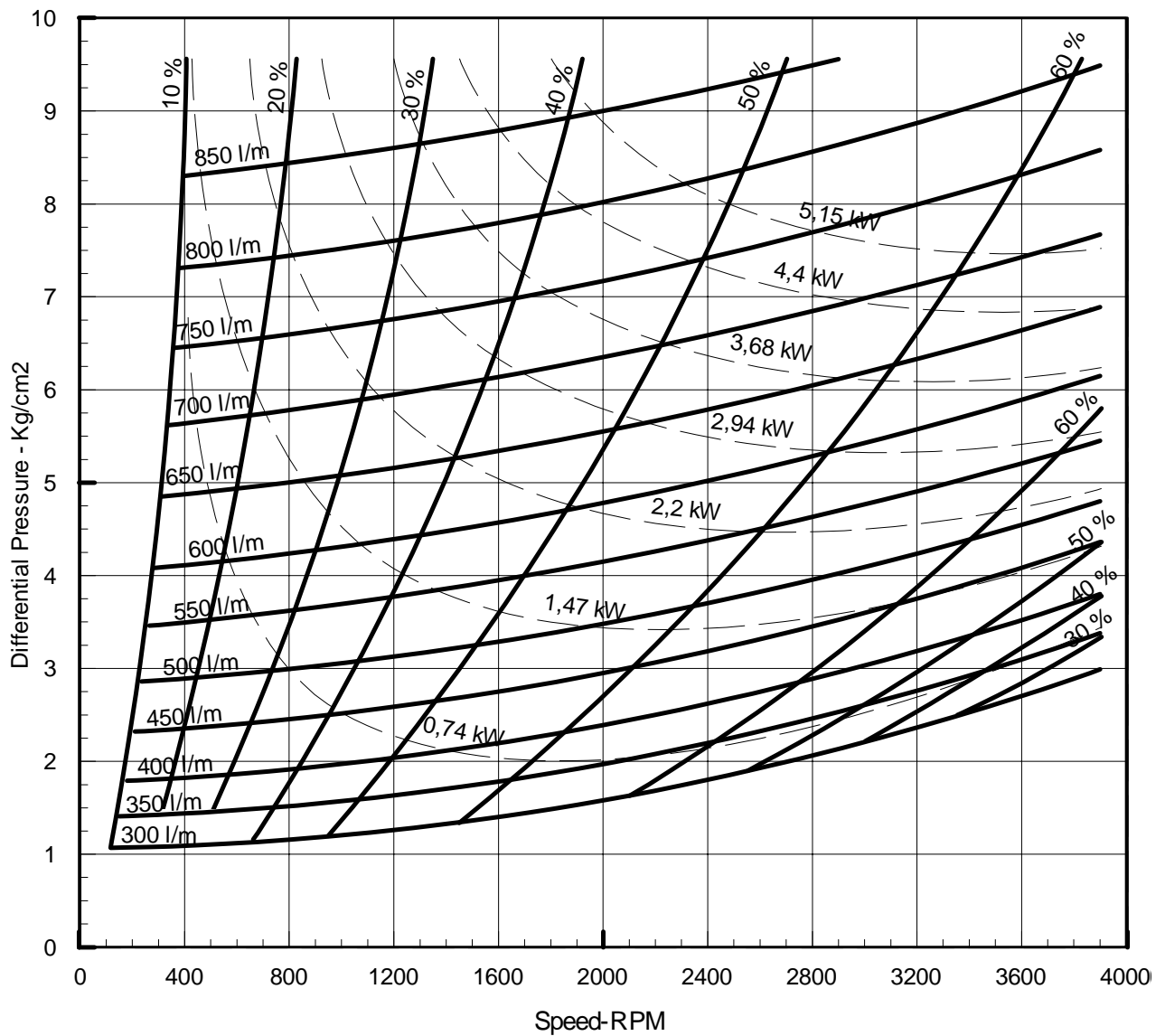

N Y B O R G A S

N-6230 SYKKYLVEN, NORWAY  
TEL +47 70 25 40 80 - FAX +47 70 25 29 08  
office@nyborgfan.com - www.nyborgfan.com

## MPV - A1EGSX



# NYBORG PORTABLE AXIAL FLOW FAN WATER CONSUMPTION CHART

## MPV - A1EGSX

WATER MOTOR : GILKES 4,25F WM 0,20 VENT

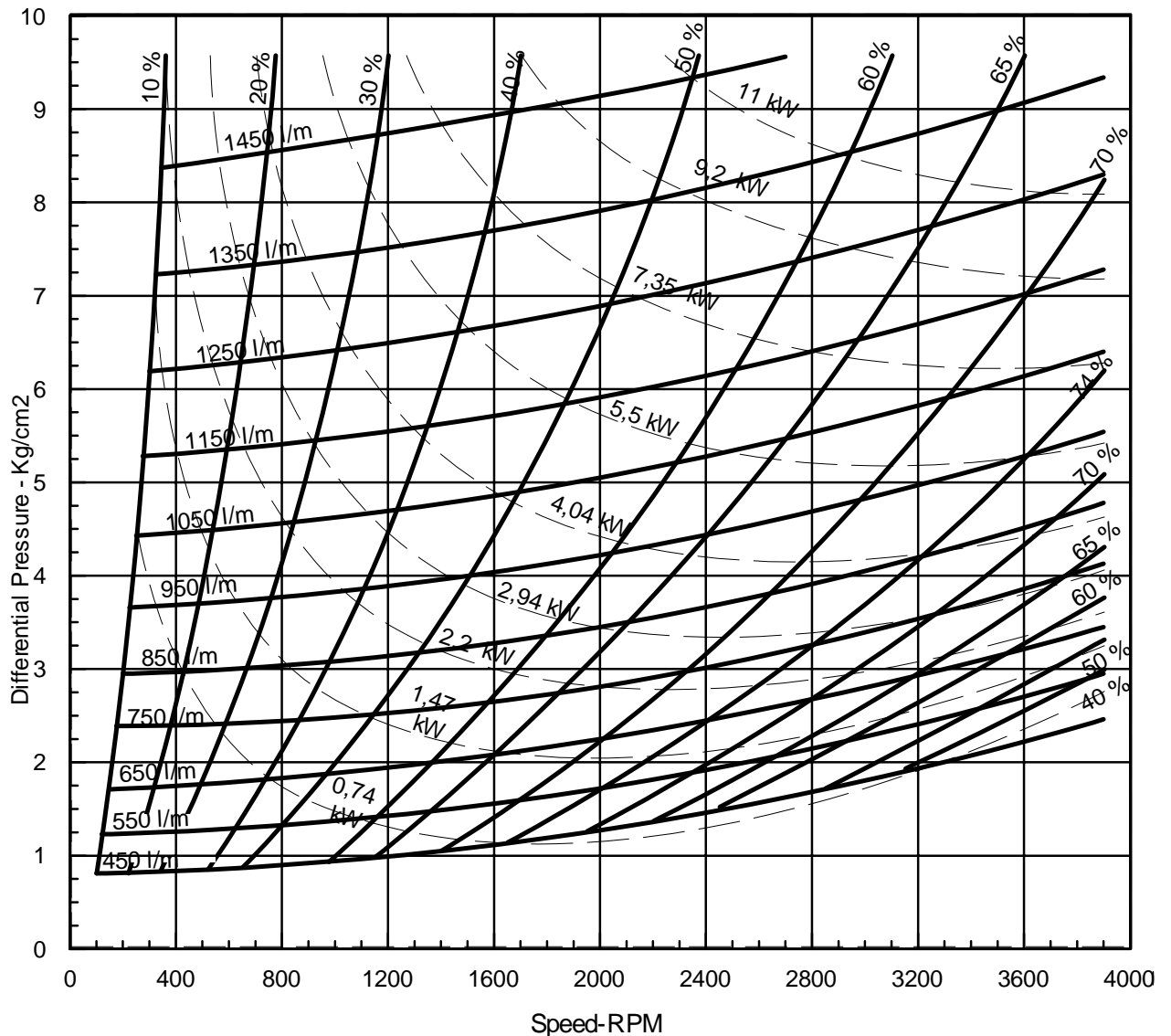

N Y B O R G A S

N-6230 SYKKYLVEN, NORWAY  
TEL +47 70 25 40 80 - FAX +47 70 25 29 08  
office@nyborgfan.com - www.nyborgfan.com

## MPV - A1EGSX



# NYBORG PORTABLE AXIAL FLOW FAN WATER CONSUMPTION CHART

## MPV - A1EGSX

WATER MOTOR : GILKES 4,25F WM 0,30 VENT

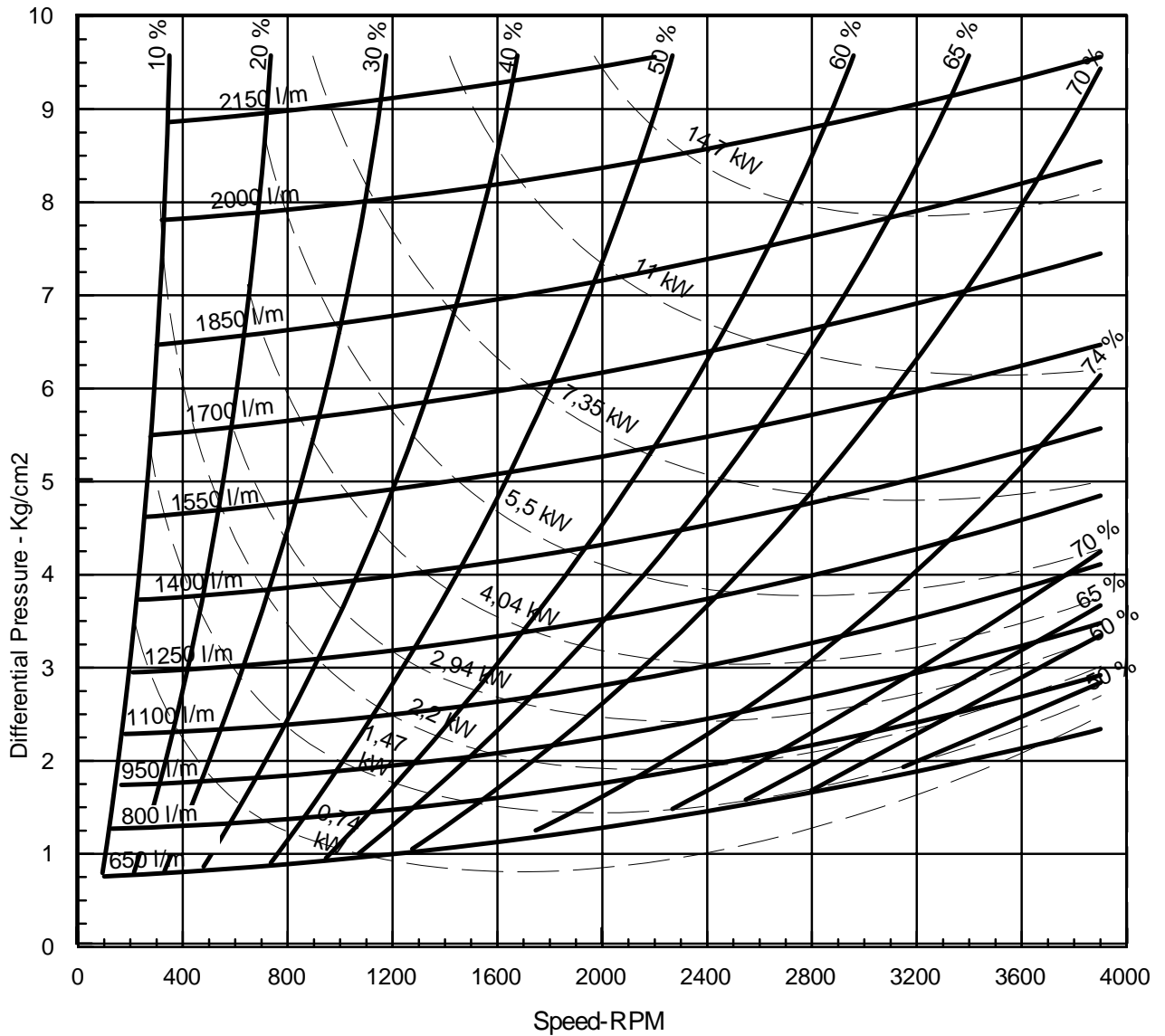

N Y B O R G A S

N-6230 SYKKYLVEN, NORWAY  
TEL +47 70 25 40 80 - FAX +47 70 25 29 08  
office@nyborgfan.com - www.nyborgfan.com

## MPV - A1EGSX



# NYBORG PORTABLE AXIAL FLOW FAN WATER CONSUMPTION CHART

**MPV -  
A1EGSX**

WATER MOTOR : GILKES 4,25F WM 0,40 VENT

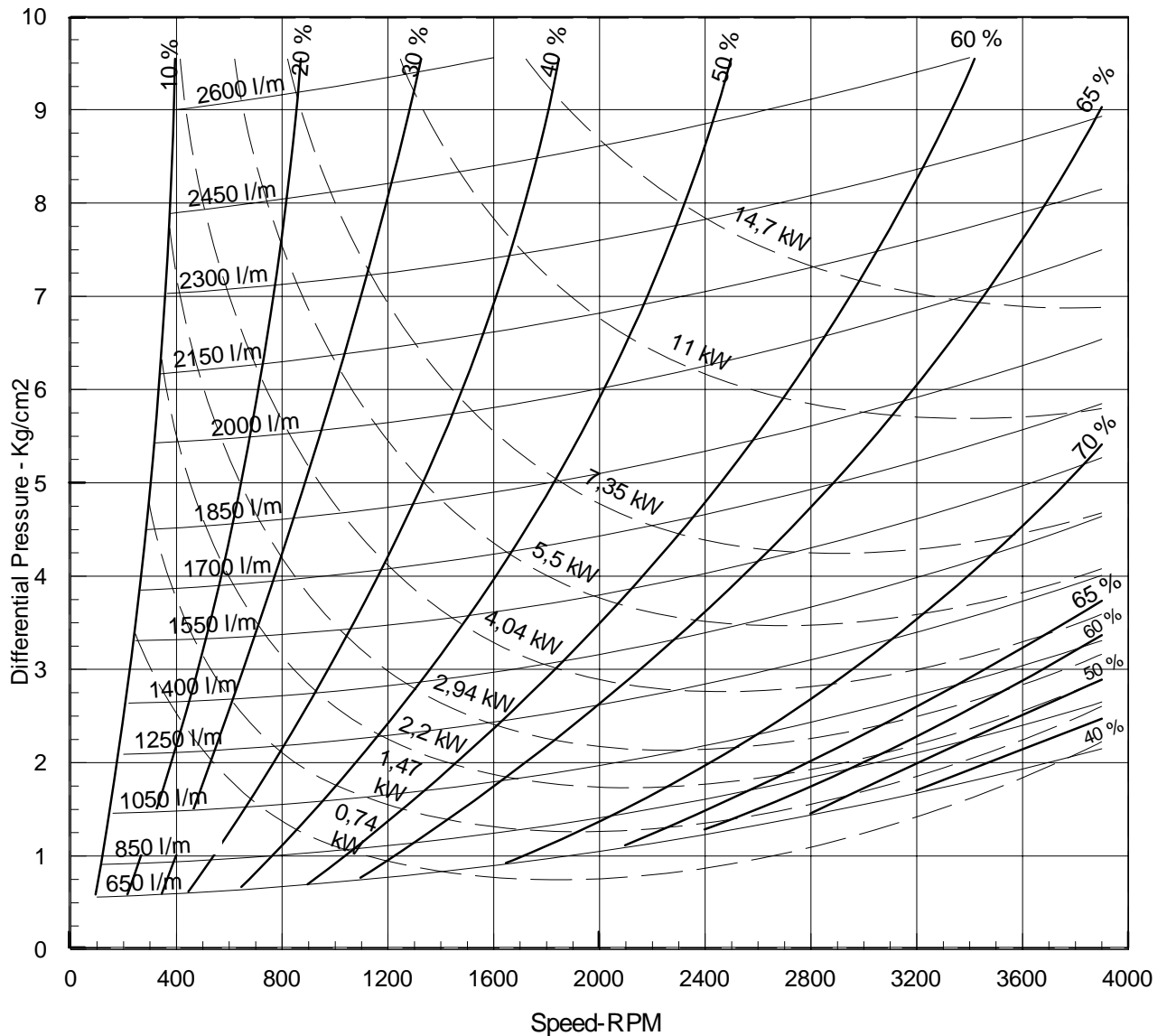

**N Y B O R G A S**

N-6230 SYKKYLVEN, NORWAY  
TEL +47 70 25 40 80 - FAX +47 70 25 29 08  
office@nyborgfan.com - www.nyborgfan.com

**MPV -  
A1EGSX**